

ZOOMLION TECHNOLOGY WITH INGENUITY AND CARE 科技中联, 匠心相伴



The world's leading excavator intelligent manufacturing factory

全球领先的挖掘机智能制造工厂

Zoomlion Smart City Earthmoving Machinery Park is an industry-leading intelligent and flexible excavator factory. From a piece of steel plate to an excavator, with high-precision welding process, highly reliable assembly process, high-level coating process and strict quality control, each excavator is delivered with ultimate quality.

中联智慧产业城土方机械园区拥有行业领先的智能化、柔性化的挖掘机工厂, 从一块钢板到一台挖掘机, 以高精度的焊接工艺、高可靠的装配工艺、高级别的涂装工艺和严苛的品质管控, 让每一台交付的挖掘机都具备极致品质。

ZOOMLION

Zoomlion Heavy Industry Science & Technology Co.,Ltd.

Add: No.361, South Yinpen Road, Changsha, Hunan Province, P.R.China 410013 Email: earthmoving@zoomlion.com
Copyright © 2024 Zoomlion. All rights reserved. Reproduction and copying of any part of contents is not allowed for any purposes without Zoomlion's approval.
Note: Materials and specifications are subject to change without notice. Featured machines in photos may include additional equipment.



ZOOMLION 340 HORSEPOWER CRAWLER BULLDOZER

中联重科340马力履带式推土机
ZD340G



ZOOMLION

VISION CREATES FUTURE

思想构筑未来

ZD340G

Engine rated power (发动机功率): 257 kW / 2000 rpm

Operating weight (操作重量):

35260 kg (Standard 标配)

39781 kg (With single-shank ripper and ROPS 带单齿松土器和防翻架)

40628 kg (With triple-shank ripper and ROPS 带三齿松土器和防翻架)



Power System 动力系统

It is paired with a Cummins engine, which has a large output torque, low fuel consumption, and low noise, high reliability and long life.
康明斯发动机, 输出扭矩大, 油耗小, 噪音低, 可靠性高, 寿命长。

Hydraulic System 液压系统

The hydraulic line is sealed with a 24° cone and the layout of this line has been optimized for greater safety and reliability.
液压管路采用24°锥密封, 管路布局优化, 更加安全可靠。

Working Equipment 工作装置

The new structure of the two braces straight tilting shovel, so the structure is more reasonable, more balanced force, higher reliability;
全新两撑杆直倾铲, 结构更合理, 受力更均衡, 可靠性更高;
The shovel blade is made of wear-resistant steel for better abrasion resistance and longer service life.
铲刀采用耐磨钢材, 耐磨性更好, 使用寿命更长。

Electrical System 电气系统

It is equipped with advanced electronic monitoring system, color LCD screen + pointer gauge co-display, vehicle data information display is clear and concise, good human-machine interaction.
先进的电子监控系统, 彩色液晶屏+指针仪表共同显示, 车辆数据信息显示清晰明了, 人机交互好。

Cab 驾驶室

16% increase in cab space;
驾驶室空间增加16%;
The sealing performance is improved, and the noise at the driver's ear is reduced by 2.4dB.
密封性提升, 司机耳边噪音降低2.4dB。

Transmission System 传动系统

The final drive adopts 2-stage cylindrical spur gear reduction, splash lubrication, high transmission torque and high reliability;
终传动采用二级圆柱直齿轮减速, 飞溅润滑, 传动扭矩大, 可靠性高;
The transmission system is more reasonably matched to the engine, and the transmission is more efficient and reliable.
传动系统与发动机匹配合理, 传递效率更高, 更可靠。

STRONG POWER

动力强劲

Cummins NTA855 engine 康明斯NTA855发动机

It is powered by a Cummins engine with a customized torque curve, with multi-stage filtration of the air intake system, cleaner intake air, less pollution, green environmental protection, high efficiency and energy saving; strong power, low fuel consumption and high reliability.

配置康明斯发动机, 定制扭矩曲线, 进气系统多级过滤, 进气更洁净, 污染少, 绿色环保, 高效节能; 动力强劲, 油耗低, 可靠性高。

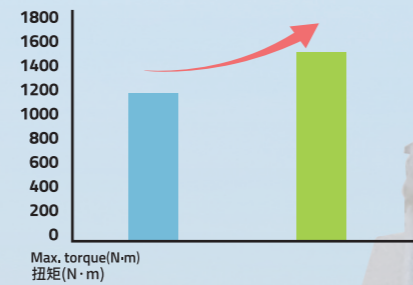
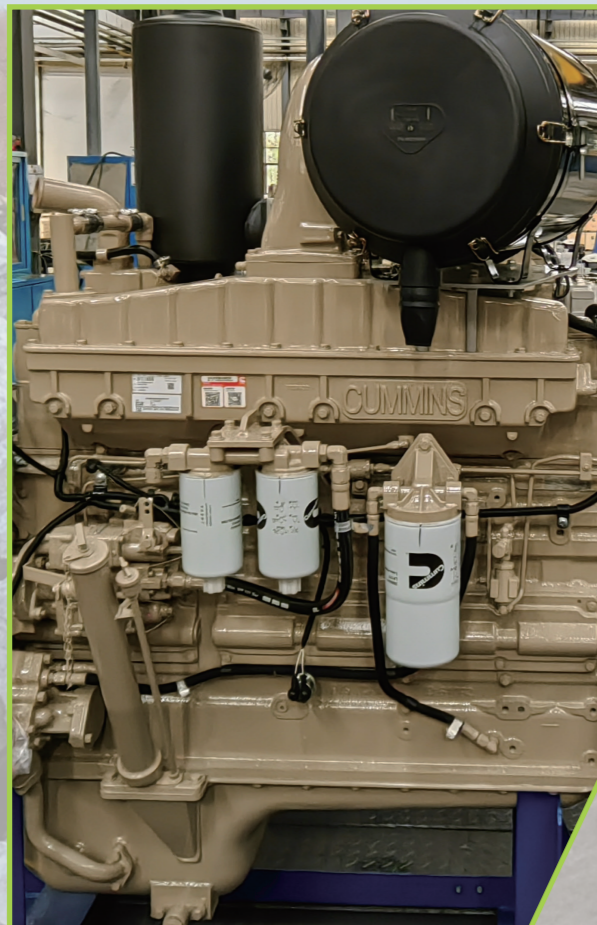

Customized engine that is more powerful increases its Max. torque to 1509N·m
定制化发动机, 作业更有力, 最大扭矩提升至1509N·m

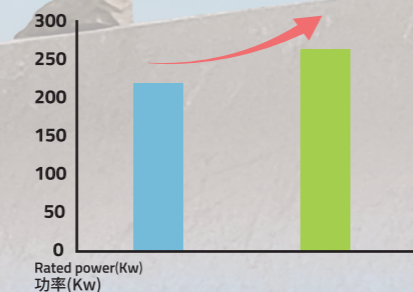

Customized engine with stronger power increases its rated power to 257kW
定制化发动机, 动力更强劲, 额定功率提升至257kW

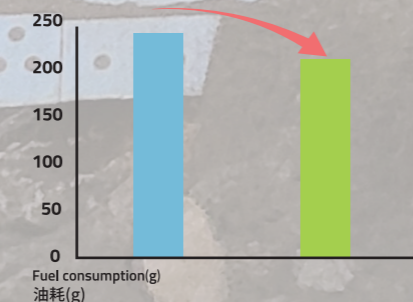

Customized engine that saves energy and has high efficiency decreases its fuel consumption to 208g/kW.h
定制化发动机, 节能高效, 油耗降低至208g/kW.h

RELIABLE & DURABLE

可靠耐用

New straight-tilt blade with two struts 新型两撑杆直倾铲

It adopts a new type of horizontal spacer, from the original four to two spacers, of which the indirect head rotates around the axis in a certain angle, effectively reducing the impact of spacer up and down jumping and spacer swing amplitude, so the movement is more reasonable, higher reliability.

新型水平撑杆, 由原四根变为两根撑杆, 中间接头在一定角度内围绕轴旋转, 有效减少撑杆上下跳动冲击, 撑杆摆动幅度小, 运动更合理, 可靠性更高。

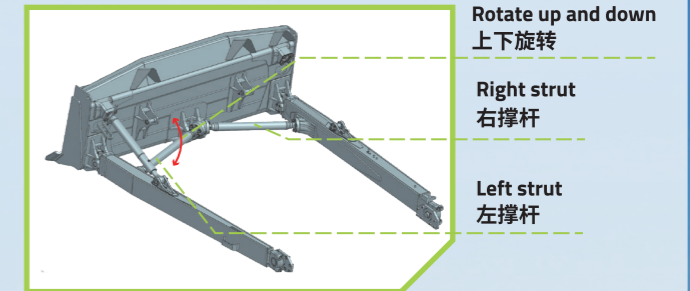

New straight-tilt blade with two struts 双边支重轮

Dual-side track rollers have stronger load bearing capacity, which will have better track chain movement guidance; at the same time, the whole machine is more stable in operation and has better passability, which can effectively extend the service life of the whole machine.

双边支重轮承重能力更强, 履带轨链运动导向性更好, 整机更稳定, 通过性更好, 有效延长整机的使用寿命。

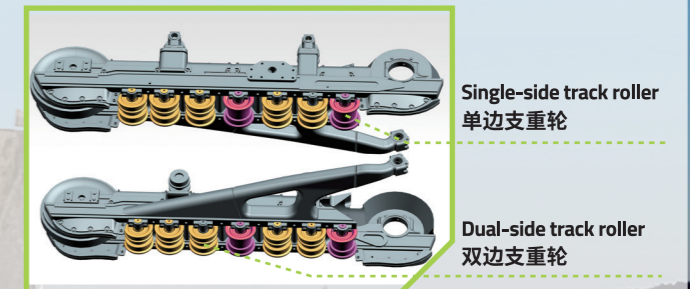

Straight through prefilter (Standard) 直通式预滤器 (标配)

Its standard straight-through pre-filter effectively separates dust, sand, pulverized coal and other impurities in the air, combining with the engine's multi-stage air filter to improve recent cleanliness and eliminate early engine wear.

标配直通式预滤器, 有效分离空气中的灰尘、沙粒、粉煤等杂质, 结合发动机多级空滤, 提高近期清洁度, 杜绝发动机早期磨损。



Turbocharger (Standard) 涡轮增压器 (标配)

The turbocharger, which improves and widens the high efficiency zone, increases the intake air pressure ratio, improves combustion, reduces fuel consumption rates, and can improve the engine's ability to adapt to altitude.

涡轮增压器, 提高和拓宽了高效区, 增加进气压比, 改善燃烧, 降低了燃油比耗, 并提高发动机适应海拔高度的能力。



INNOVATIVE QUALITY

品质革新

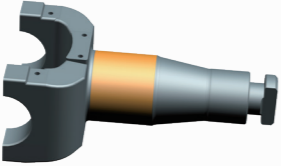
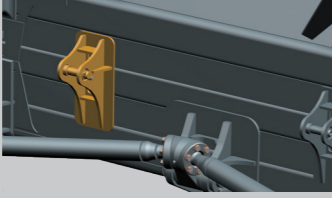
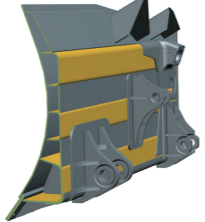
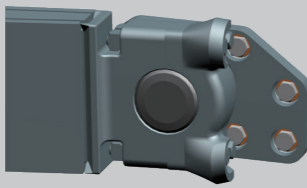
Model 机型	Adaptive Improvements 适应性改进
Increase the diameter of the lifting cylinder's rotating shaft 提升油缸转轴直径加大	 <p>The diameter of the spindle is increased from $\phi 125\text{mm}$ to $\phi 140\text{mm}$ with higher strength and reliability. 转轴直径由$\phi 125\text{mm}$增加到$\phi 140\text{mm}$, 强度更高更可靠。</p>
Optimization of blade lifting cylinder support reinforcement 铲刀提升油缸支座加强	 <p>The support structure has been optimized with longer weld seams to improve the adaptability to heavy-duty working conditions. 优化支座结构, 焊缝加长, 提升重载工况适应性。</p>
Multi-stage "U" plate structure 多段式"U"型板结构	 <p>The rear box plate is optimized for "3U" type plate welding, with good weldability and high blade strength. 后箱板优化成"3U"型板拼焊, 焊接工艺性好, 铲刀强度高。</p>
Increase in the spherical size of the trunnion of the blade 铲刀耳轴球面尺寸加大	 <p>Increase the effective contact area of the trunnion to enhance structural reliability. 加大球体有效接触面积, 提升结构可靠性。</p>

COMFORTABLE & SAFE

舒适安全

The top-mounted, high-powered air conditioner boasts faster cooling and its performance is 22% better for a more comfortable driving;

顶置大功率空调, 制冷更快, 性能提升22%, 驾乘更舒适;

Cab: its use of profiled skeleton, the inner and outer door panels are stamping molding sealing is optimized; cab with a cigarette lighter, fire extinguisher, coat hooks, cup holders and other multi-functional configurations.

驾驶室: 采用异型材骨架、内外门板冲压成型、密封优化, 点烟器、灭火器、衣帽钩、水杯托等多功能配置。

Sealed cabin with special-shaped frame
异型材骨架密封驾驶室



The top-mounted, high-powered air conditioner
顶置大功率空调



Special-shaped frame
异型材骨架



Multiple Functional Configurations
多种功能配置



CUSTOMER SERVICE

客户服务

CONVENIENT MAINTENANCE

维保便利



Oil filter maintenance
机油滤更换



Air cleaner maintenance
空滤清理



Fuel filter maintenance
燃油滤更换



Replacing fuse
保险更换



Refueling
燃油加注



Refilling engine oil
加注机油

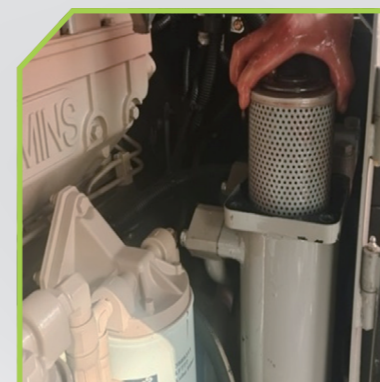

Transmission filter maintenance
变速滤芯更换

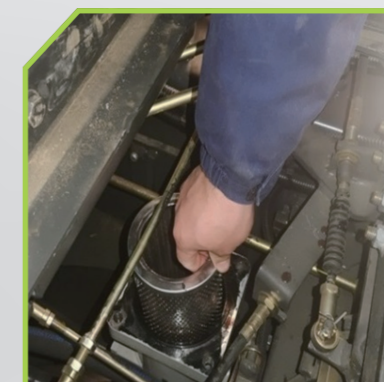

Undercarriage filter maintenance
底盘粗滤更换



Hydraulic oil filter maintenance
液压油箱滤芯更换

Zoomlion promises that once you choose us, we are ready to respond with the first arrival and solution any time, anywhere.
中联重科承诺,一旦您选择了我们,我们将随时做好响应准备,在任何时间、任何地点第一时间到达并提供解决方案。

Various service content, professional service teams, global service networks and systematic technical support are readily available from Zoomlion for an effective response and solution upon your request no matter where you are in the world and what time it is.

中联重科随时提供各种服务内容、专业服务团队、全球服务网络和系统化的技术支持,无论您身处何时何地,均可应您的要求提供有效的响应和解决方案。

TECHNICAL PARAMETERS

技术参数

ZD340G	
Engine (发动机)	
Model 型号	Cummins 康明斯NTA855-C360S10
Type 型式	Inline, coolant cooled, 4 stroke, turbocharged, direct-injection 直列、水冷、四冲程、增压、直喷
Displacement 发动机排量	14 L
Rated speed 额定转速	2000 rpm
Rated power 额定功率	257 kW
Maximum drawbar pull 最大牵引力	>337 kN (Forward I; Standard without loosener) (前进I档; 标准配置, 不带松土器)
Maximum torque 最大扭矩	1509 N.m/1400 rpm
Generator 发电机	28 V, 60 A
Transmission (传动装置)	
Torque converter 液力变矩器	3元件1级1相 3 Components 1 stage 1 phase
Gearbox 变速箱	Power shift planetary transmission 动力换挡行星变速箱
Type 型式	PPlanetary gear, multi-disc clutch, manual control, power shift 行星齿轮、多片离合、手动操纵、动力换挡
Gear and speed 变速档位、速度	Forward I 前进 I 档 : 0-3.6 km/h Forward II 前进 II 档 : 0-6.6 km/h Forward III 前进 III 档 : 0-11.5 km/h Reverse I 后退 I 档 : 0-4.4 km/h Reverse II 后退 II 档 : 0-7.8 km/h Reverse III 后退 III 档 : 0-13.5 km/h
Cooling method 冷却方式	Water cooled 水冷
Central drive 中央传动	Spiral bevel gear, Splash lubricated 螺旋伞齿轮、飞溅润滑式
Undercarriage (底盘)	
Suspension type 悬挂方式	Semi-rigid, balanced beam floating type 半刚性、平衡梁浮动式
Number of carrier rollers (each side) 托链轮数 (每侧)	2
Number of track rollers (each side) 支重轮数 (每侧)	7
Number of idler (each side) 引导轮数 (每侧)	1
Track type 履带型式	Assembled, single grouser 装配式、单履齿
Track pitch 履带节距	228.6 mm
Number of track pad (each side) 履带板数 (每侧)	41
Ground pressure (kPa) 接地比压 (kPa)	97.5 kPa
Ground clearance 离地间隙	500 mm
Minimum turning radius 最小转弯半径	3500 mm

ZD340G	
Steering system (转向系统)	
Steering clutch 转向离合器	Wet type, multi-disc clutch type, spring pressing, operating oil pressure action 湿式、多片离合器式、弹簧压紧、操作油压动作
Steering brake 转向制动器	Wet, floating belt, pedal operation (with hydraulic booster) 湿式、浮动带式、脚踏操作 (附油压助力器)
Final drive 终传动	Spur gear two-stage reduction, splash lubrication 直齿轮二级减速、飞溅润滑
Operating weight (kg) (操作重量)	
Standard 标配	35260 kg
With single-tooth looseners and anti-tip racks 带单齿松土器和防翻架	39781 kg
With three-tooth looseners and anti-tip racks 带三齿松土器和防翻架	40628 kg
Hydraulic control mechanism (液压控制机构)	
Type 型式	Gear pump 齿轮泵
Working pressure 工作压力	14 MPa
Maximum flow 最大流量	360 L/min
Control method 控制型式	Slide valve type 滑阀式
Working equipment (工作装置)	
Blade material 刀片材料	31SiCrMoB
Blade cylinder diameter 铲刀油缸缸径	140 mm
Service refill capacities (服务保养加注容量)	
Cooling system 冷却系统	101 L
Fuel tank 燃油箱	650 L
Engine oil 发动机油底壳	Lower level 28L, upper level 36L 下液位28L, 上液位36L
Rear axle box, torque converter, gearbox 后桥箱、液力变矩器、变速箱	185 L
Final drive (each side) 终传动 (每侧)	55 L
Working equipment oil tank 工作装置油箱	97 L
Lubrication system (润滑系统)	
Gearbox 变速箱	forced lubrication 强制润滑
Central drive 中央传动	splash lubrication 飞溅式润滑
Final drive 终传动	splash lubrication 飞溅式润滑
Gradeability (爬坡能力)	
	30°

DIMENSION

整机尺寸

ZD340G	
Straight Tilt Blade 直倾铲	
A Overall length (without ripper) 总长度 (无松土器)	6583 mm
A' Overall length (with single-shank ripper) A' 总长度 (带单齿松土器)	9077 mm
B Overall width (Blade width) 总宽度 (铲刀宽度)	4130 mm
C Overall height (to cab top) 总高度 (至驾驶室顶端)	3575 mm
C' Overall height (to the top of anti-rollover frame) C' 总高度 (至防翻架顶端)	3692 mm
D Track pad width 履带板宽度	560 mm
E Track gauge 履带中心距	2140 mm
F Length of track on ground 履带接地长度	3150 mm
G Blade height 铲刀高度	1590 mm
H Maximum lift of blade above ground 铲刀最大提升高度	1627 mm
J Maximum drop of blade below ground 铲刀最大下降量	560 mm
K Maximum tilt of blade 铲刀最大倾角	1010 mm
Blade capacity 铲刀容量	10.5 m³

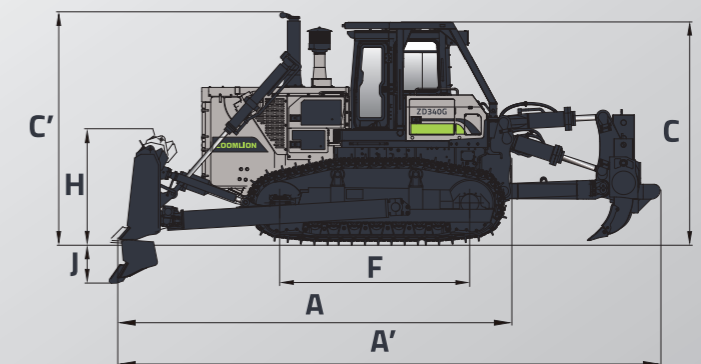
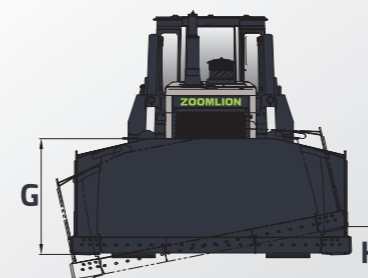
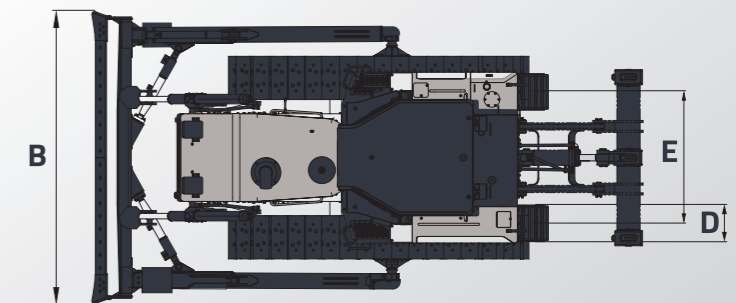

WORKING DEVICES 工作装置

Straight Tilt Blade(Standard) 直倾铲(标配)

It can be tilted up and down in the vertical plane, with good flexibility, greater cutting force and leveling ability, suitable for sand, gravel, hard soil and other relatively hard materials.

在垂直面内可上下倾斜,具有良好的灵活性、更大的切入力和平整能力,适合于砂石、硬土等比较坚硬的物料。

Semi-U Blade (Optional) 半U型铲(选配)

Semi-U blade has the characteristics of both straight tilting blade and U blade, which not only has a large cutting force, but also has a good gathering effect in the process of bulldozing, which is suitable for a variety of working conditions.

半U型铲同时具备直倾铲和U型铲的特点,不但推土切削力大,而且推土过程中有很好的聚拢效果,适用于多种工况的作业要求。

Single-Shank Ripper (Optional) 单齿松土器(选配)

It can be used for large area excavation of frozen soil, hard road surface, mine stripping construction and farmland infrastructure, instead of the traditional drilling and firing construction, so the construction is safer.

可用于大面积开挖冻土、坚硬的路面、矿山剥离施工和农田基建,代替传统的打眼放炮施工,作业施工安全。

Rock Blade (Optional) 岩石铲(选配)

Double-layer arc plate and so on are made of high-strength wear-resistant NM400 steel plate, double-layer reinforcement of both side plate. Anti-collision wall, U-plate structure rear box plate and strengthened push frame ensures high reliability.

双层弧板等均采用高强耐磨NM400钢板,两侧板双层加强,并设置防撞墙,U型板结构后箱板,加强推架,可靠性高。

Sanitation Blade (Optional) 环卫铲(选配)

This kind of blade is usually used in large and medium-sized garbage disposal site. The special raised part of the upper part of the blade can avoid the materials going into the back of the blade.

一般用于大中型垃圾处理场作业,铲刀上部特有的加高栏栅,可避免作业物料进入铲刀后侧。

Triple-Shank Ripper (Optional) 三齿松土器(选配)

This ripper is mainly used for loosening hard pavement or frozen soil, and can effectively improve the stripping efficiency of hard shi layer when working with bulldozer.

主要用于疏松坚硬的路面或冻土,与推土铲配合作业,可有效提高硬土层剥离效率。

STANDARD & OPTIONAL LIST 标选配清单

Classification (分类)	Configuration items (配置项)	ZD340G
Engine 动力系统	Engine brand 发动机品牌	●Cummins 康明斯
	Rated power 发动机功率	257 kw / 2000 rpm
	Diesel filter stage 柴油滤清器级数	3 stages 3级
	Air cleaner 空滤	●
	Air pre-cleaner 进气预滤	●
Radiator 水箱	Normal radiator 普通水箱	●
	High cooling capacity radiator 沙漠水箱	○
Hydraulic system 液压系统	Working pump 工作泵	●
	Multiple valve 多路阀	●
Transmission 传动系统	Torque converter 变矩器	●
	Gearbox 变速箱	●
Electrical system 电气系统	Reversing alarm 倒车报警	●
	Caution light 警示灯	●
	Fuel level sensor 燃油液位传感器	●
	GPS	●
Front working equipment 前工作装置	Straight Tilt Blade 直倾铲	●
	Rock Blade 岩石铲	○
	Sanitation Blade 环卫铲	○
Rear working equipment 后工作装置	Semi-U Blade 半U型铲	○
	Triple-shank ripper 三齿松土器	○
	Single-shank ripper 单齿松土器	○
Travel system 行走系统	7 Track rollers 标配台车架	●
	Track 560 mm 履带	●
	Track 610 mm 履带	○
	Track 660 mm 履带	○
Cab 驾驶室	Long fender assembly 长挡泥板总成	●
	Seat 座椅	●
	Radio 收音机	●
FOPS&ROPS	Fire extinguisher 灭火器	●
	Four pillars anti-tip frame 四柱防翻架	○
Air conditioner 空调系统	Six pillars anti-tip frame 六柱防翻架	○
	Heating and cooling air conditioner 冷暖空调	○
	Cooling only air conditioner 单冷空调	○

STANDARD 标配 ●

OPTIONAL 选配 ○